

Lux-FS 170x85

PREDINSTALACIJA
 PREDINSTALLATION
 PREINSTALLATION
 VORINSTALLATION

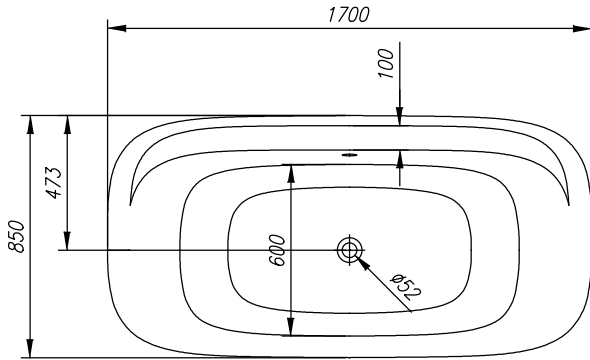
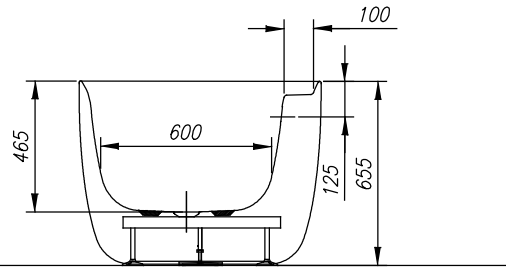
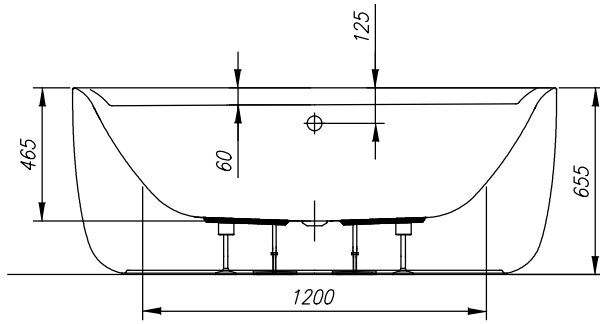
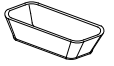

215 L

VOLUMEN
 VOLUMEN
 VOLUME
 VOLUMEN

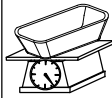

43 kg

TEŽA
 TEŽINA
 WEIGHT
 GEWICHT

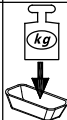

345 kg

MAX. OBREMENITEV
 MAX. OBTEREČENJE
 MAX. LOAD
 MAX. BELASTUNG

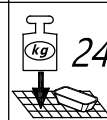

240 kg/m²

OBREMENITEV TAL
 OBTEREČENJE PODA
 FLOOR LOAD
 BODENBELASTUNG

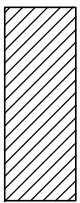

- Priklop tople in hladne vode 1/2", min 0,2 Mpa, max 0,4 Mpa
- Priključak tople i hladne vode 1/2", min 0,2 Mpa, max 0,4 Mpa
- Connection of hot and cold water 1/2", min 0.2Mpa, max 0.4Mpa
- Anschluss Warm- und Kaltwasser 1/2", min 0,2 Mpa, max 0,4 Mpa
- Prostor za odtok Ø 50 mm
- Mjesto za odtok Ø 50 mm
- Drain spot Ø 50mm
- Abflussplatz Ø 50 mm

*priporočilo za vgradnjo
 preporuka za ugradnju
 installation recommendation
 Einbauempfehlung*

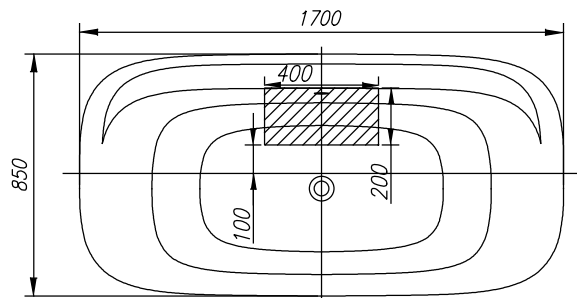

Samostoječa FS kopalna kad - navodilo za vgradnjo
 FS samostoječa kada - upute za ugradnju
 FS freestanding bathtub - installation instructions
 FS Freistehende Badewanne - Einbauanleitung

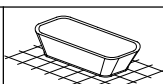

Nr. MK 22

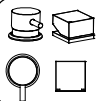

- MEŠALNI VENTIL TOPLA/HLADNA
- VENTIL ZA MIEŠANJE TOPLO/HLADNO
- MIXING VALVE HOT/COLD
- MISCHVENTIL WARM/KALT



- PREKLOPNIK ROČNA PRHA/IZLIV
- PREKIDAČ ZA RUČNI TUŠ/IZLJEV
- HAND SHOWER/SPOUT SELECTOR SWITCH
- SCHALTER FÜR HANDBRAUSE/AUSLAUF

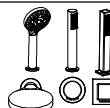

- ROČNA PRHA
- RUČNI TUŠ
- HAND SHOWER
- HANDBRAUSE

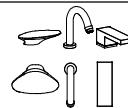

- IZLIV
- IZLJEVNIK
- SPOUT
- AUSLAUF

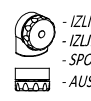

- IZLIV NA PRELIVNI GARNITURI
- IZLIEV NA PRELJEVNOM SETU
- SPOUT ON THE OVERFLOW SET
- AUSLAUF AN DER ÜBERLAUFGARNITUR

- OPCIJA ENOROČNA ARMATURA WATERFALL
- OPCIJA JEDNORUČNA ARMATURA WATERFALL
- OPTION ONE HAND FITTING WATERFALL
- MÖGLICHKEIT EINWEG-ARMATUR WATERFALL

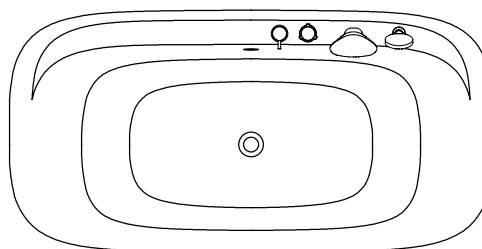
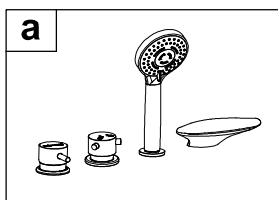

- OPCIJA ENOROČNA ARMATURA GEYSER
- OPCIJA JEDNORUČNA ARMATURA GEYSER
- OPTION ONE HAND FITTING GEYSER
- MÖGLICHKEIT EINWEG-ARMATUR GEYSER

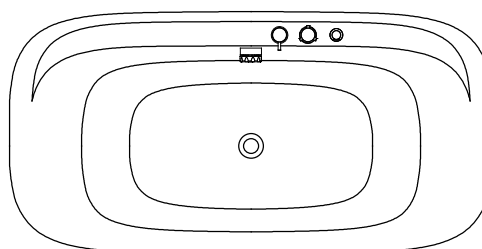
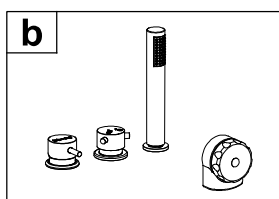

- OPCIJA ENOROČNA ARMATURA RAINDROP
- OPCIJA JEDNORUČNA ARMATURA RAINDROP
- OPTION ONE HAND FITTING RAINDROP
- MÖGLICHKEIT EINWEG-ARMATUR RAINDROP

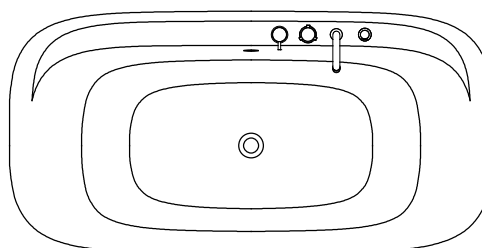
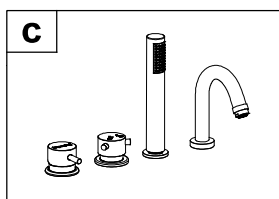

- OPCIJA ENOROČNA ARMATURA STREAM (CHR / BLACK)
- OPCIJA JEDNORUČNA ARMATURA STREAM (CHR / BLACK)
- OPTION ONE HAND FITTING STREAM (CHR / BLACK)
- MÖGLICHKEIT EINWEG-ARMATUR STREAM (CHR / BLACK)

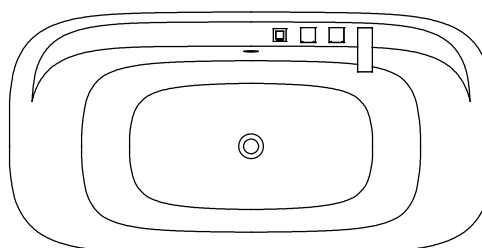
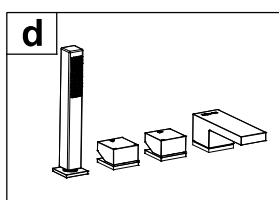

LUX-FS 170x85

V NAVEDENO KOPALNO KAD NE VGRAJUJEMO MASAŽNIH SISTEMOV

3/3

U NAVEDENU KUPAONSKU KADU NE UGRAĐUJEMO MASAŽNIH SISTEMOV

WE DO NOT INSTALL MASSAGE SYSTEMS IN THE GIVEN BATHTUB

IN DER ANGEgebenEN BADEWANNE WERDEN MASSAGESYSTEMEN NICHT EINGEBAUT